



User Manual

E2Pro Smart Diagnostic System

Shenzhen Xtooltech Intelligent CO., LTD.

Please read this user manual carefully before using the Smart Diagnostic System, referred to as the “Scan Tool” throughout this document. When reading the manual, please pay attention to the words “Note” or “Caution”, and read them carefully for appropriate operation.

OPERATION INSTRUCTIONS

For safe operation, please follow the instructions below:

- Keep the device away from heat or fumes when in use.
- If the vehicle battery contains acid, please keep your hands and skin or fire sources away from the battery during testing.
- The exhaust gas of the vehicle contains harmful chemicals. Please ensure adequate ventilation.
- Do not touch the vehicle cooling system components or exhaust manifolds when the engine is running due to the high temperatures reached.
- Make sure the car is securely parked, Neutral is selected or the selector is at the P or N position to prevent the vehicle from moving when the engine starts.
- Make sure the (DLC) Diagnostic Link Connector is functioning properly before starting the test to avoid damage to the Diagnostic Computer.
- Do not switch off the power or unplug the connectors during testing.
- Doing so may damage the ECU (Electronic Control Unit) and/or the Diagnostic Computer.

CAUTIONS!

- Avoid shaking, dropping or dismantling the scan tool as it may damage the internal components.
- Use only your fingertips to touch the LCD screen. Hard or sharp objects may damage the scan tool.
- Do not use excessive force.
- Do not expose the screen to strong sunlight for a long period.
- Please keep the scan tool away from water and moisture.
- Store and use the scan tool only within the temperature ranges identified in the Technical Specifications section.
- Keep the unit away from strong magnetic fields.

AFTERSALES-SERVICES

E-Mail: supporting@xtooltech.com

Tel: +86 755 21670995 or +86 755 86267858 (China)

Official Website: www.xtooltech.com

Catalogue

| | |
|---|----|
| 1 General Introduction | 4 |
| 1.1 Outlook & Ports | 4 |
| Tablet | 4 |
| 1.2 Specifications | 5 |
| 2 Getting Started | 6 |
| 2.1 Navigation Buttons | 6 |
| 2.2 Vehicle Connection | 7 |
| 2.2.1 Wireless Connection | 7 |
| 2.2.1 Wired Connection | 7 |
| 3 Diagnosis | 9 |
| 3.1 Guide to Activation | 9 |
| 3.2 Introduction of Diagnosis Application | 11 |
| 3.3 Diagnosis Application Setting | 13 |
| 3.4 Battery pack detection | 16 |
| 3.5 Diagnostic menu | 17 |
| 3.5.1 Vehicle Selection | 17 |
| 3.5.2 Common diagnostic functions | 19 |
| 3.5.3 Component Test | 25 |
| 3.5.4 Updates | 25 |
| 3.5.5 Report | 26 |
| 4 Remote Control | 27 |

1 General Introduction

1.1 Outlook & Ports

Tablet

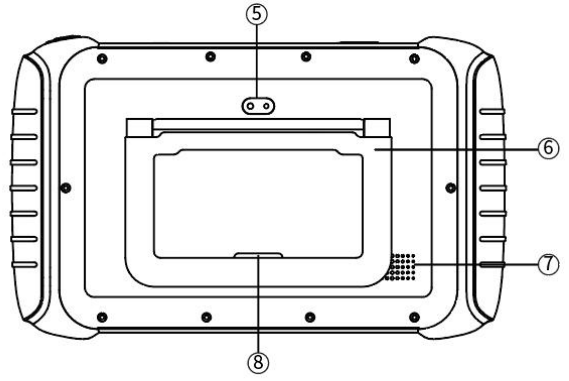
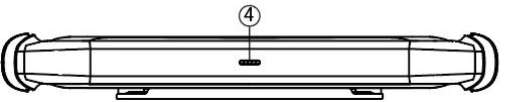
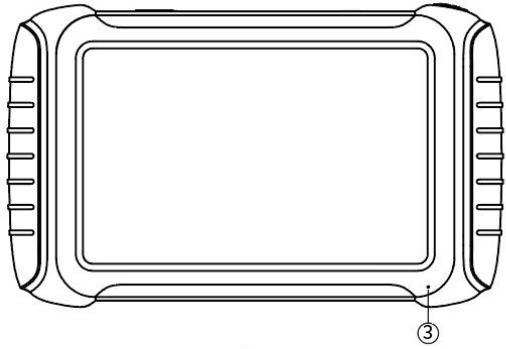

① Type-C Port

② Power Button

③ Microphone

④ Pogopin Port

⑤ Camera

⑥ Tablet Holder

⑦ Speaker

⑧ Nameplate

VCI BOX

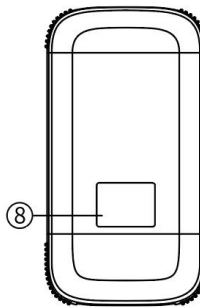
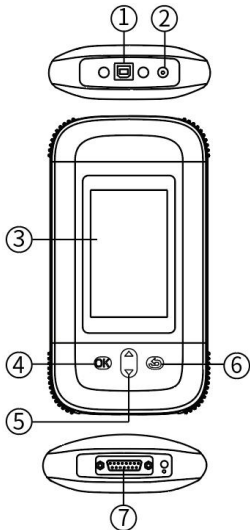

① USB Type B Port

② DC Port

③ Screen

④ OK

⑤ Up/Down Button

⑥ Return Button

⑦ DB15 Port

⑧ Nameplate

1.2 Specifications

Operating System: Android

Processor: Quad-core processor

Display: 10.1-inch capacitive screen

Resolution: 1920×1200

Battery: 6400mAh 7.2V

Camera: 8-megapixel autofocus rear camera with flash

Input voltage: 5V/3A

Operating temperature: -10~50°C









Dimensions (W x H x D): 311.0 × 190.0 × 41.0 (mm)

Caution:

1. Do not use non-standard power adapters. Otherwise at your own risk.
2. To protect the battery, please charge the device at a temperature between 0~40°C.

2 Getting Started

2.1 Navigation Buttons

| 【ITEMS】 | 【DESCRIPTIONS】 |
|---|---|
|  | Press for screenshot |
|  | Decrease volume |
|  | Back to the previous interface |
|  | Back to the main interface of the Android system |
|  | Shows recently used applications |
|  | Increase volume |
|  | Click this button to display the diagnostic vehicle interface |
|  | Press for screen recording |

2.2 Vehicle Connection

2.2.1 Wireless Connection

- Press and hold the Power button to turn on the tablet
- Select App language and start the activation
- Follow the hints to complete the activation

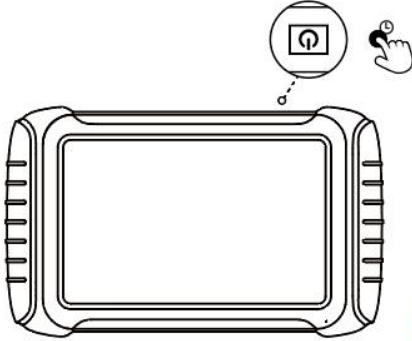

1

- Connect the DB15 connector of main cable to VCI box
- Connect the OBDII-16 connector to DB15 connector of main cable, then plug the connector into the vehicle's DLC port

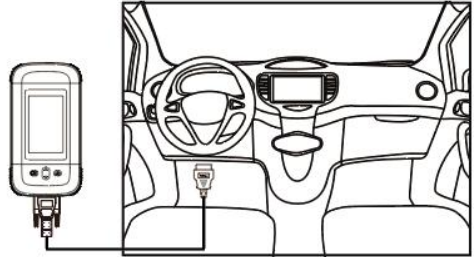

2

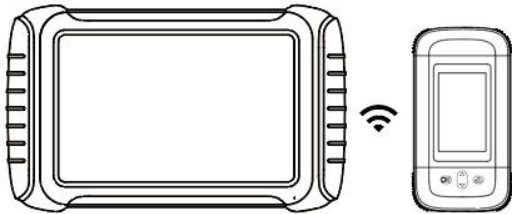

- When the VCI box gets powered on, the tablet will automatically search for it and make a WiFi connection

3

4

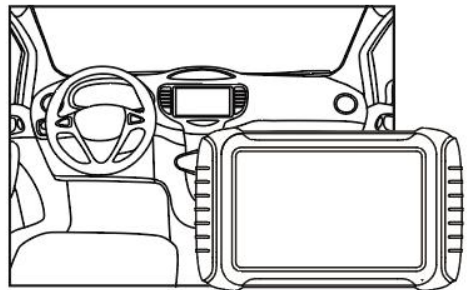

- Your tablet is now ready

2.2.1 Wired Connection

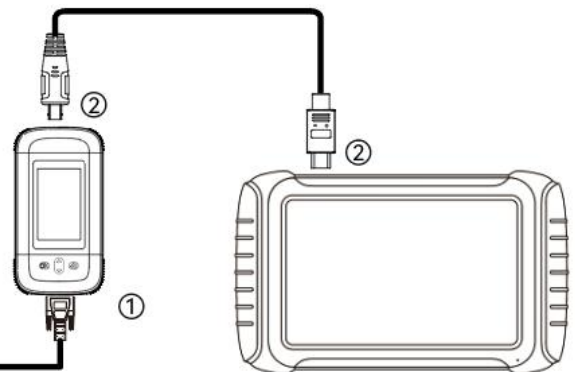
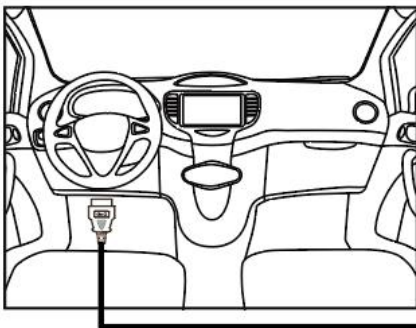

- 1. Connect DB15 connector to VCI Box; connect OBDII-16 connector to vehicle's DLC port.
- 2. Connect USB connector to VCI Box; connect Type-C connector to the tablet.

Precautions for Diagnosis

1. The voltage range on the car: +9~+36V DC;
2. When testing some special functions, the operator must operate according to the prompts and meet the test conditions. For some models [special functions], the conditions that need to be met are: engine water temperature 80 °C~105 °C, turn off headlights and air conditioners, keep the accelerator pedal in the released position, etc.;
3. The electronic control systems of different models are very complicated. If you encounter situations where it is impossible to test or a large amount of test data is abnormal, you can search for the ECU of the vehicle and select the menu for the model on the ECU nameplate;
4. If the vehicle type or electronic control system to be tested is not found in the diagnostic function, please upgrade the vehicle diagnostic software to the latest version using the Updates menu or consult the XTOOL technical service department;
5. Only wiring harnesses provided by XTOOL and designed for the device are permitted to be used with this device to avoid damage to the vehicle or the device;
6. When running a Diagnostics function, it is forbidden to shut down the device directly. You should cancel the task before returning to the main interface and then shutting down the device.

3 Diagnosis

3.1 Guide to Activation

At the first time users turn on the system, the system will automatically enter the activation guide process and request the user to select the system operating language.

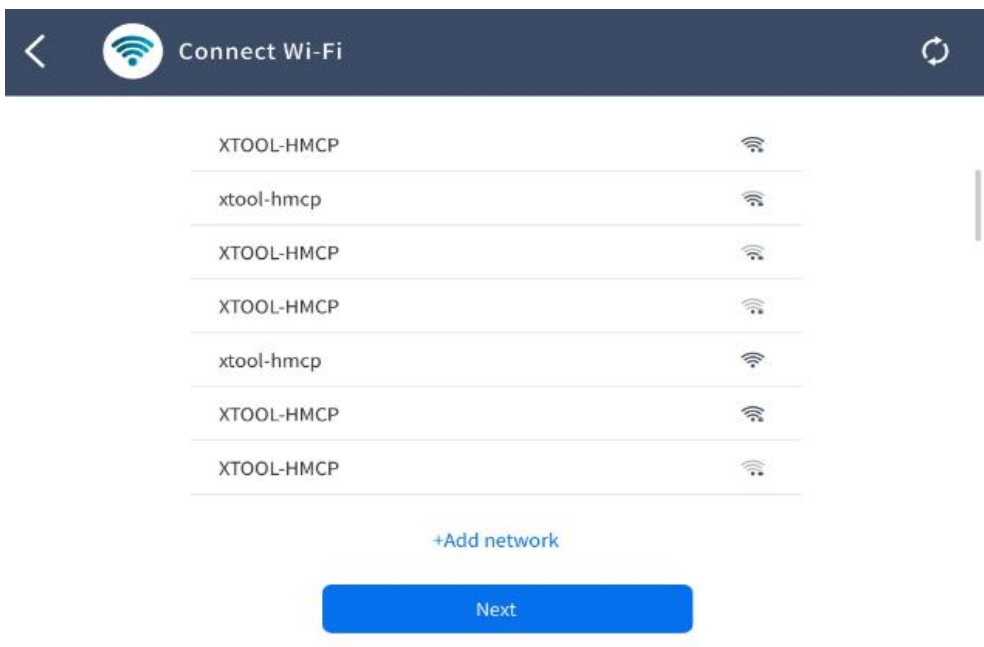
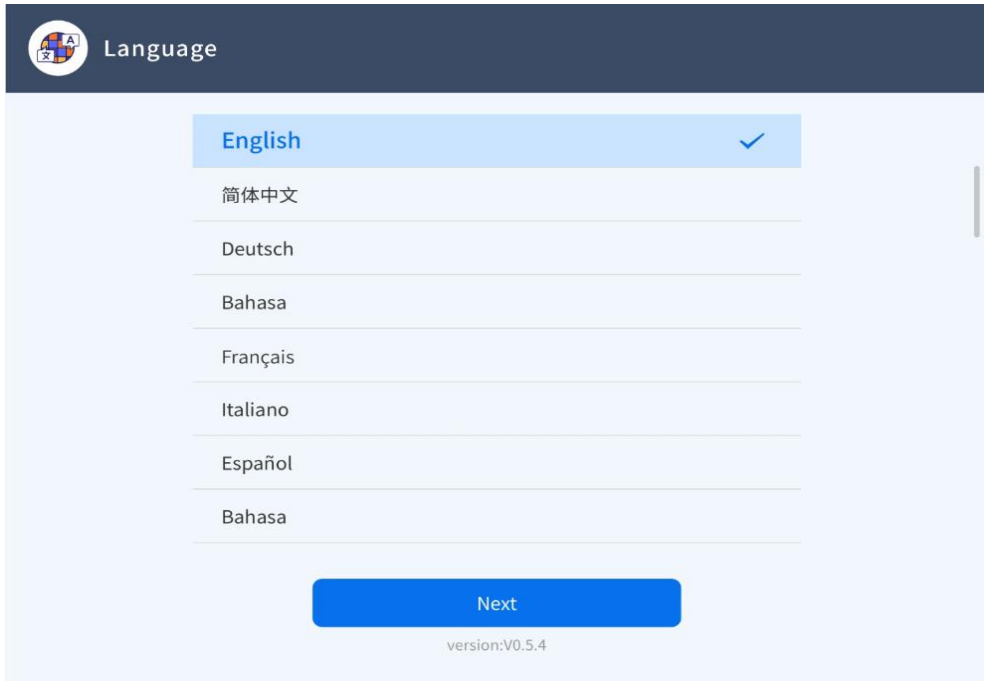

Trial

XTOOL

Welcome

Lets get started

Create Account



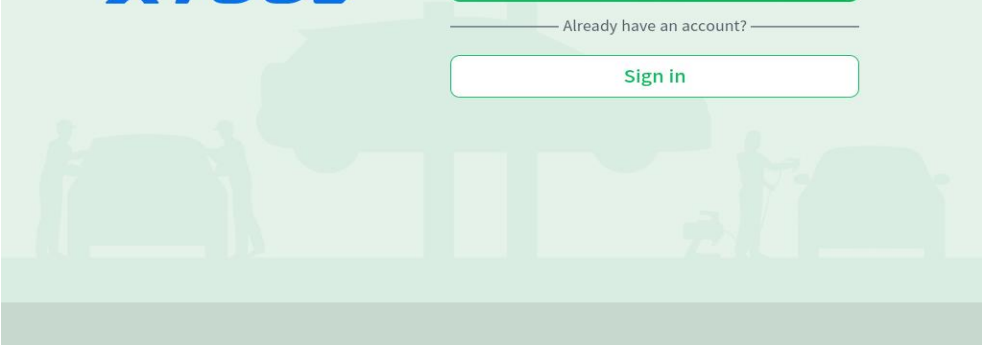

— Already have an account? —

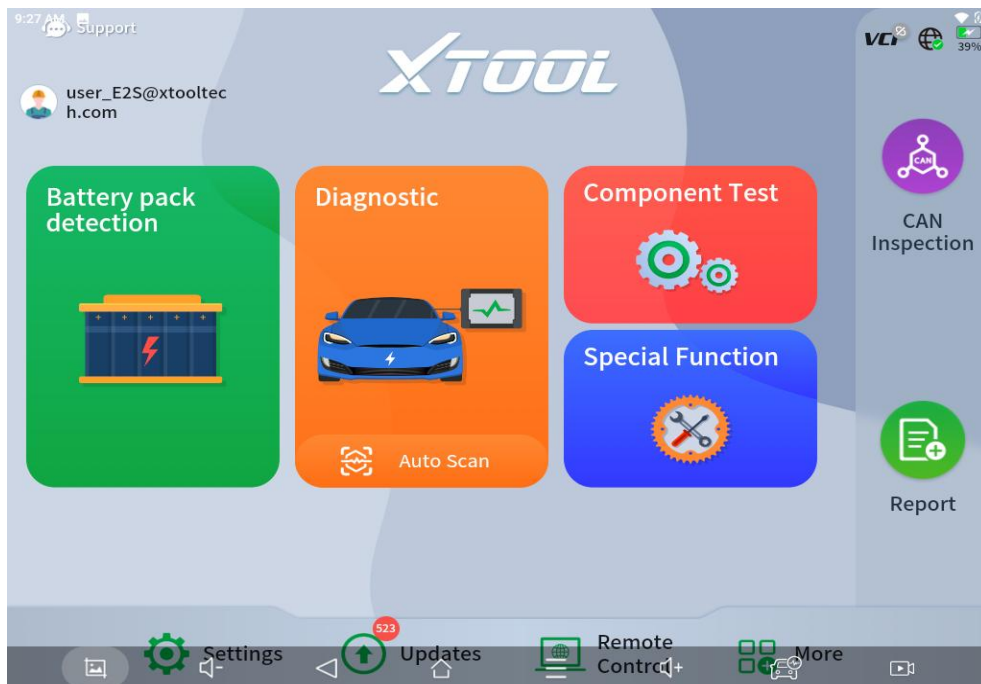

Sign in

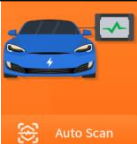

3.2 Introduction of Diagnosis Application



| 【ITEMS】 | 【DESCRIPTIONS】 |
|---|---|
|  | Diagnostic function for NEV battery |
|  | Start to diagnose / Auto identify test vehicle model and diagnose |
|  | Advanced diagnostic functions for vehicle |
|  | Here to view the saved diagnosis report and Data Playback |
|  | Here to upgrade available software |
|  | Here to set the diagnosis application, such as language etc., |

| | |
|---|--|
|  | Accept remote control assistance from after-sales team |
|  | Collect diagnosis data information |
|  | Vehicle units test (Support disassembled units) |

3.3 Diagnosis Application Setting

【Language】

Select the language you need on this page

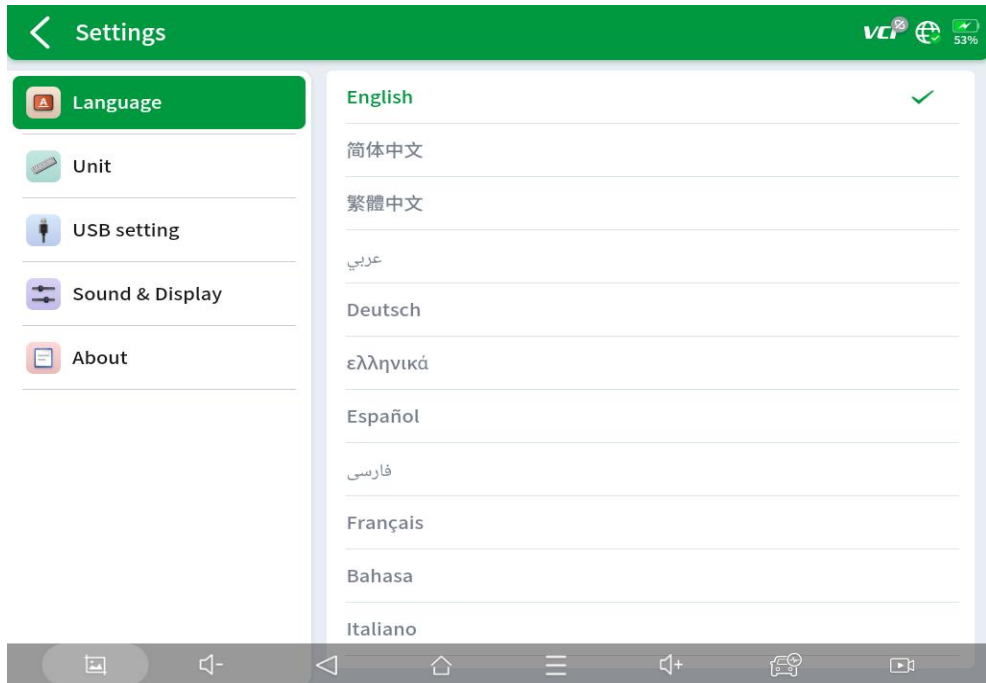

【Unit】

Select measuring units

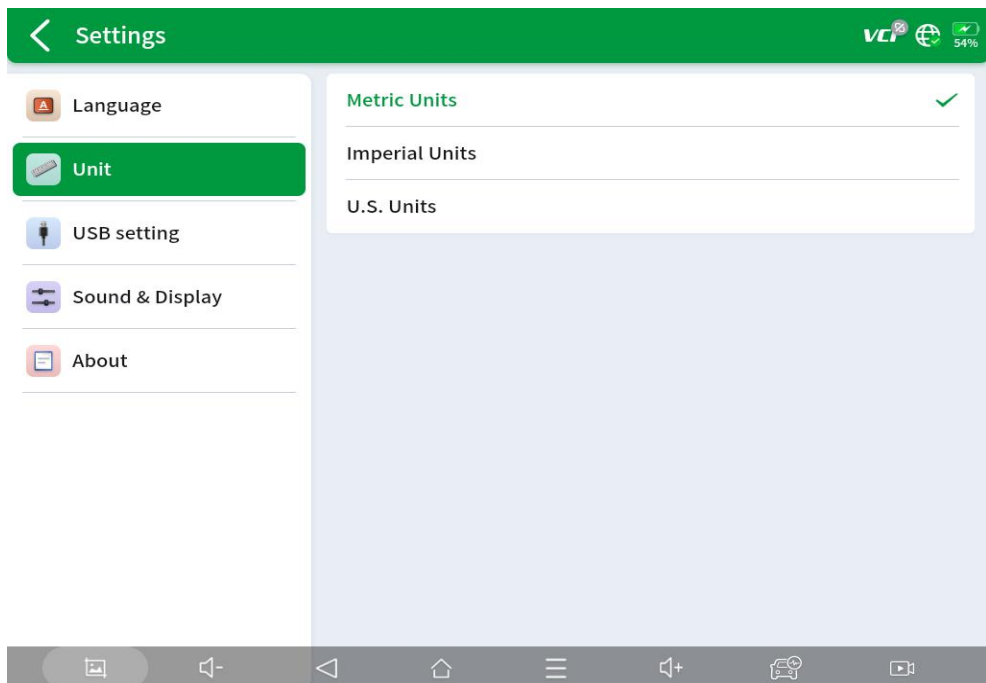

【USB setting】

Select the USB connection model you need

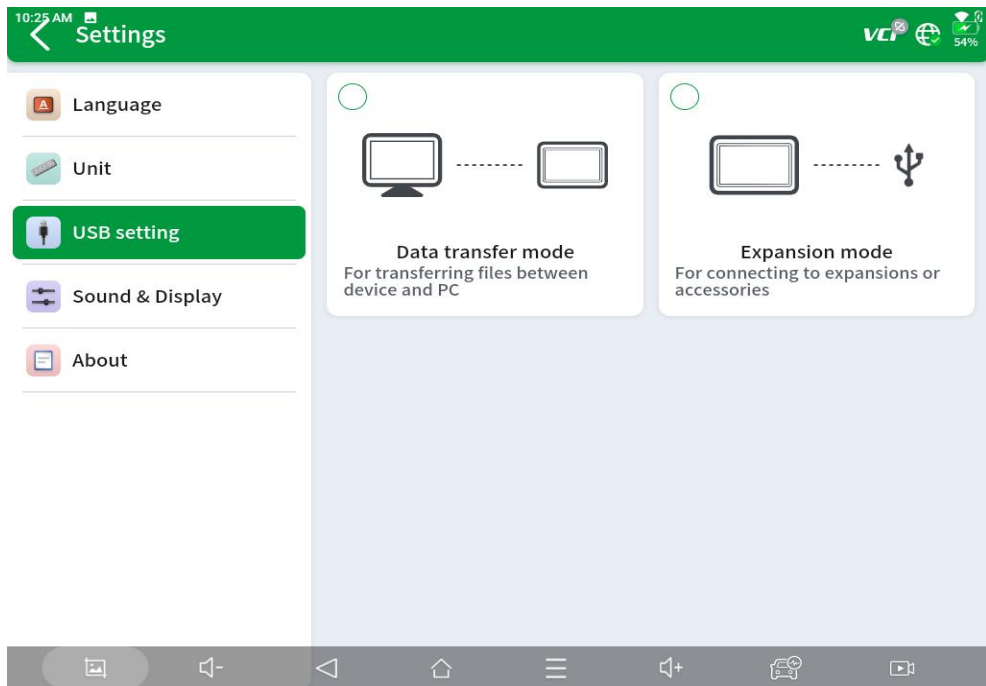

【Sound/Display】

Adjust Volume and Brightness level

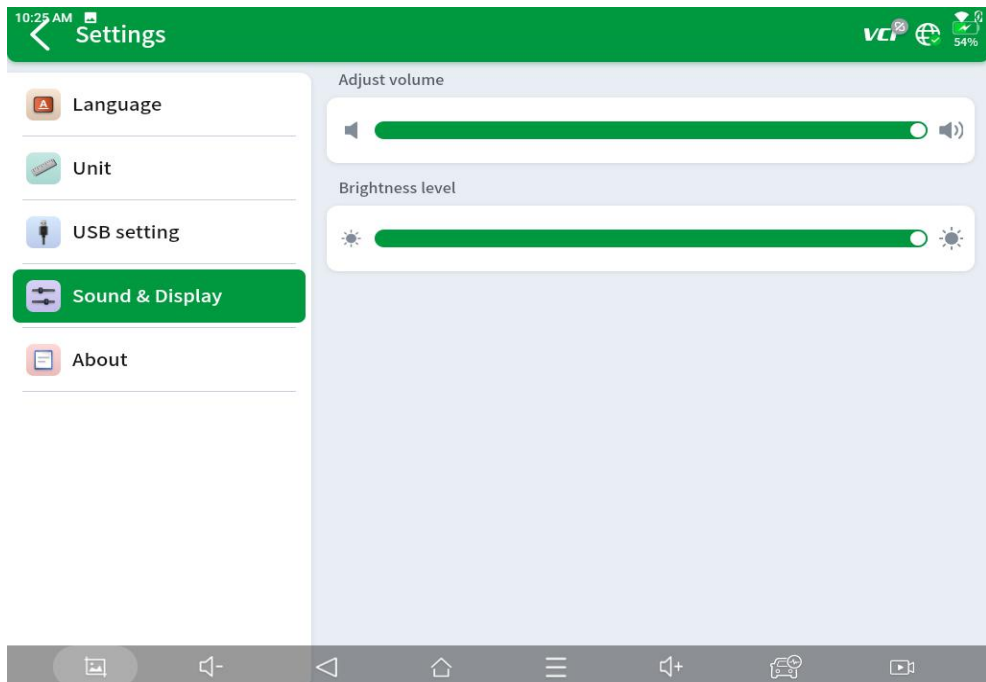

【About】

Here to check the version of diagnosis application, serial number of diagnostic tablet, and the serial number of VCI box matched

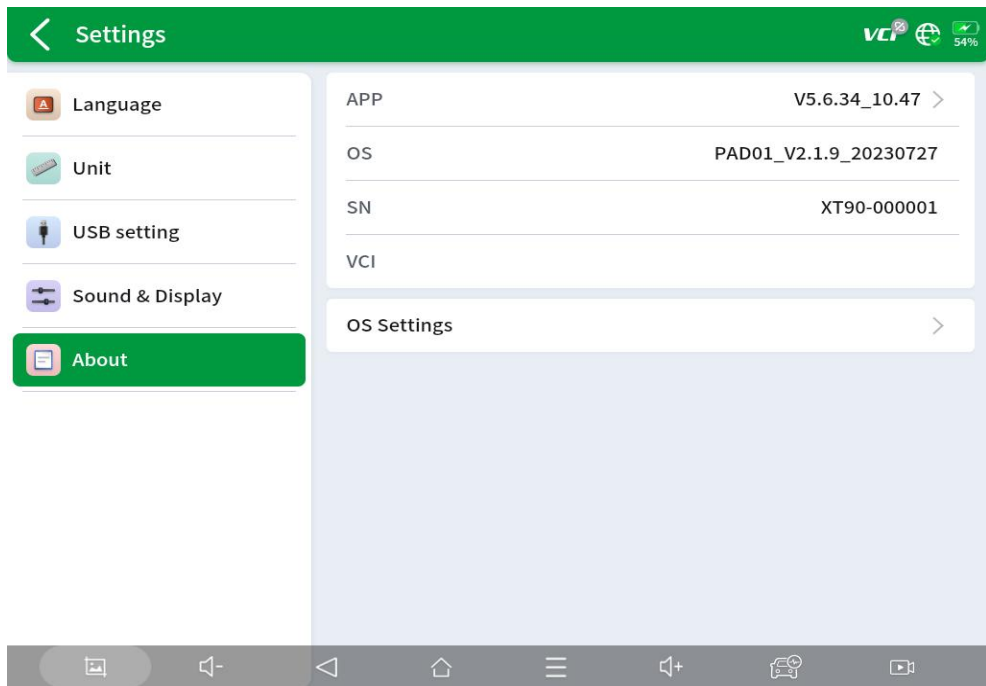

3.4 Battery pack detection

Battery pack detection can be performed via OBD or directly with included specialty cables and jumpers to monitor the voltage and temperature for battery cell.

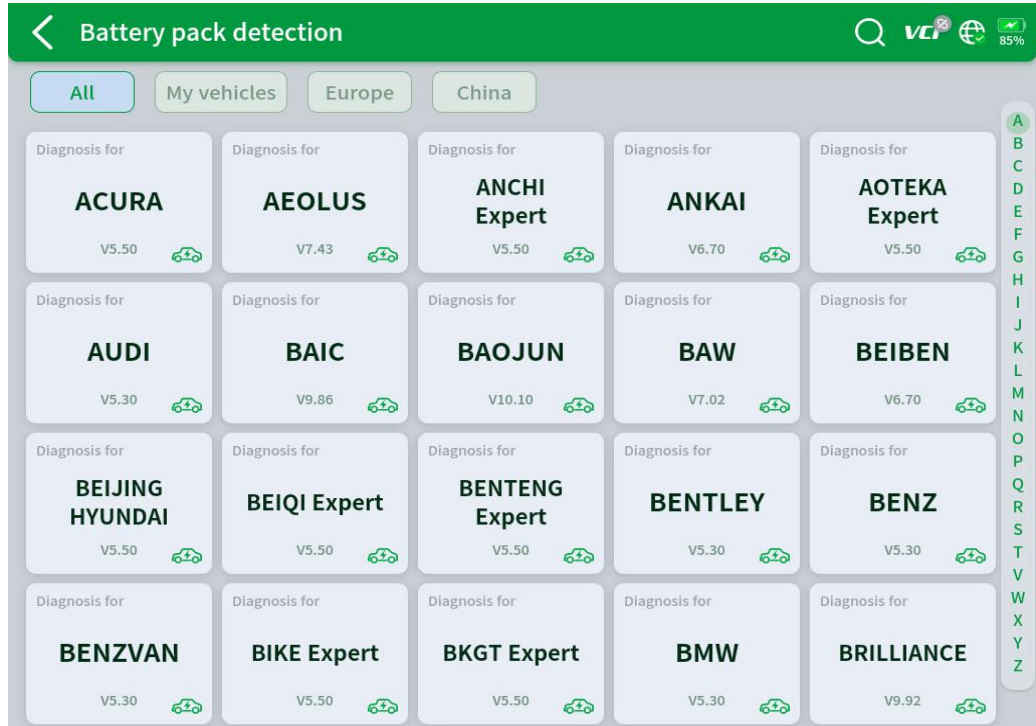

3.5 Diagnostic menu

3.5.1 Vehicle Selection

The scan tool supports the following 3 ways to access the smart diagnostics system.

- AUTO SCAN
- MANUAL INPUT
- SELECT VEHICLE BY AREA

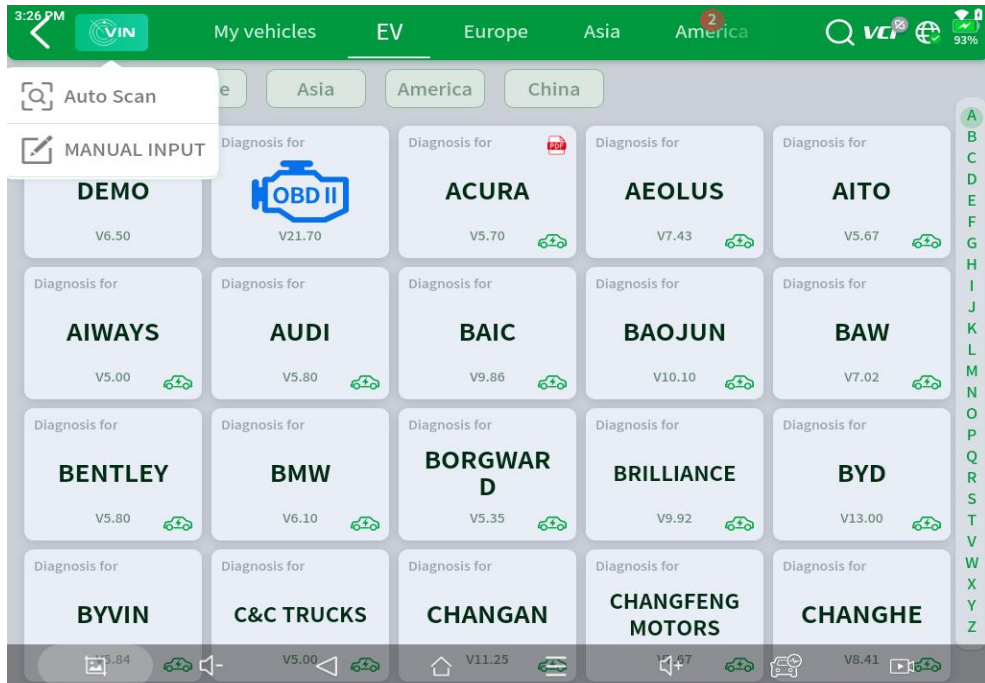

Click the VIN button in the upper left corner and then choose to enter the vehicle diagnosis through either **AUTO SCAN** or **MANUAL INPUT**.

AUTO SCAN: It supports the automatic reading of vehicle VIN code. You also can tap on the button “AUTO SCAN” on the diagnosis system entrance to use this function. Please make sure that the car and the device are well connected before using this function.

⚠ If your model is not recognized, please try the following steps:

- ① UPDATE all software, and check whether the APP is updated in [Settings]**
- ② Please click Diagnosis on the main menu to enter the selection menu, manually select the engine system to read the ECU information, and confirm whether the VIN can be read.**
- ③ Contact the XTOOL technical team to provide the VIN code to confirm whether the model supports automatic identification of VIN.**

MANUAL ENTER: It supports manual input of car VIN code. When entering the VIN code manually, make sure that the 17 characters entered are correct to ensure accurate test results.

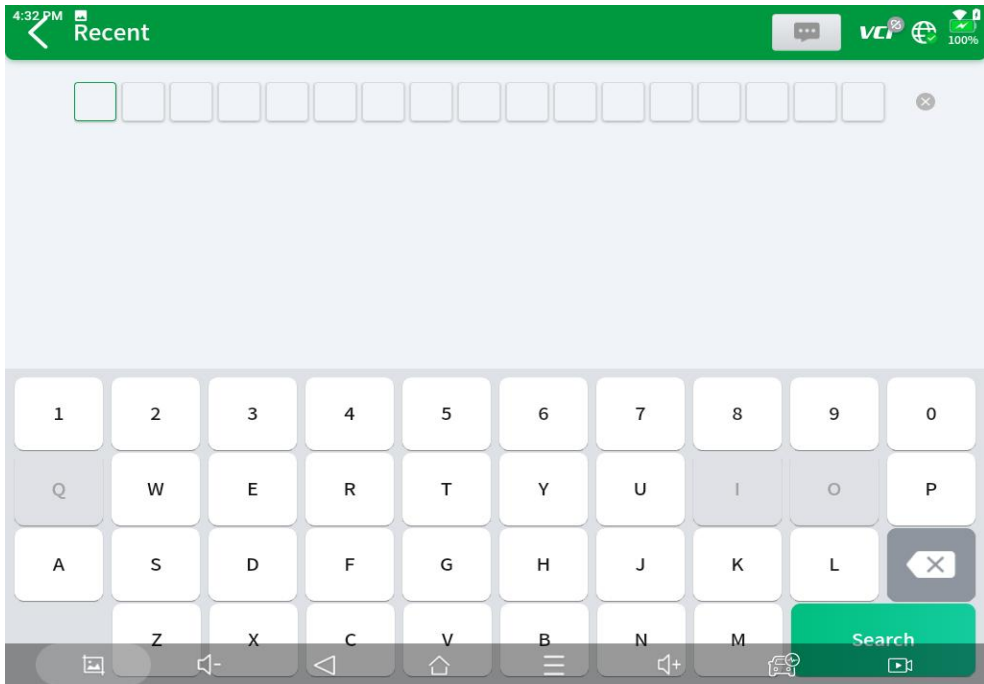

- **SELECT VEHICLE BY AREA**

In addition to the above 3 methods, you can also choose a car brand by selecting the appropriate region at the top of the screen. You can select the vehicle model that needs to be diagnosed according to the area, as shown below:



3.5.2 Common diagnostic functions

Diagnostics functions supported by the scan tool are listed below:

- **Read ECU Information**
- **Read/Clear Trouble Code**
- **Read Live Data**
- **Actuation Test (Bi-Directional Control)**
- **Special functions**

【Read ECU Information】

This function is to read ECU version information and is the equivalent of "**System Identification**" or "**System Information**" in some electronic control systems. These equivalent terms all refer to reading ECU-related software and hardware versions, models and production date of diesel engines, part numbers, etc. This information is helpful when recording maintenance records and ordering new parts.

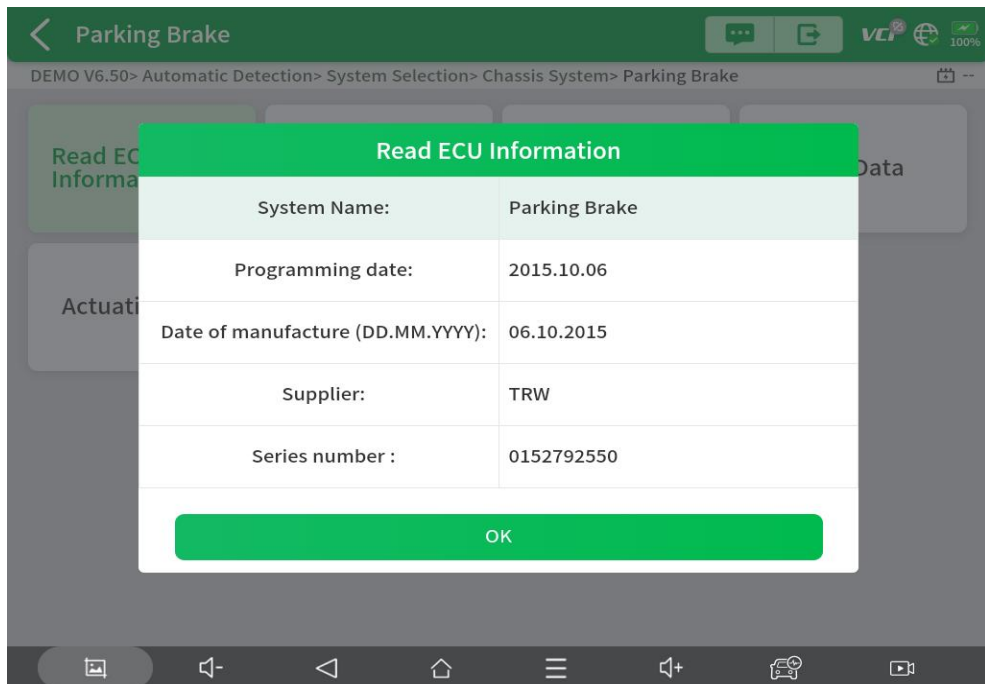

【Read Trouble Code】

In the process of diagnosis, if the device shows “System is OK” or “No Trouble Code”, it means there is no related trouble code stored in ECU or some troubles are not under the control of ECU.

Most troubles are mechanical system troubles or executive circuit troubles. It is also possible that the signal of a sensor may be inaccurate but within limits, which can be examined using Live Data.

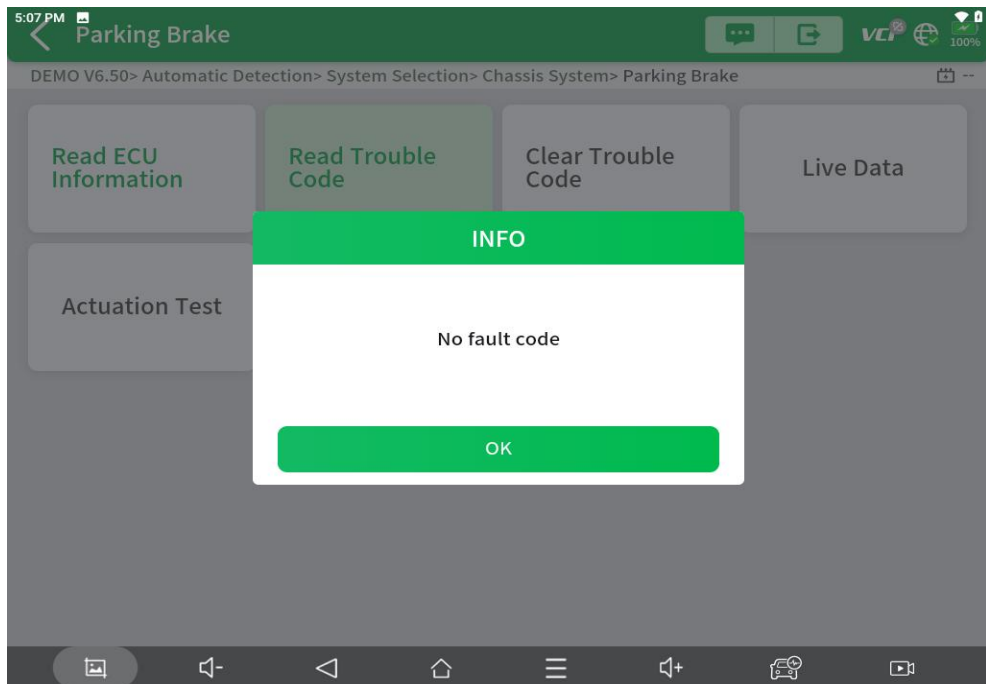

【Clear Trouble Code】

It allows for clearing current and historical trouble codes stored in the ECU memory, under the premise that all the troubles have been resolved.

Some troubles are immediately detected by the ECU with the key in the run position and without the engine running. Other troubles are not detected until very specific test conditions are met such as engine coolant temperature within a range, speed within a range for a duration of time, throttle percentage within a range, etc.

If the trouble codes are erased when the trouble remains unresolved, the trouble code will reappear in the ECU the next time the ECU performs the specific diagnostic test for that trouble.

If the trouble is resolved but there is a stored trouble code, sometimes the ECU will detect the resolution and clear the trouble code or more likely, classify it as “historical” trouble.

If the trouble is resolved and the user clears the trouble codes, the trouble history will be cleared.

If the user intends to have another colleague or mechanic investigate the problem, it is not recommended for the user to clear the trouble code since doing so may erase information helpful to others who may investigate the issue.

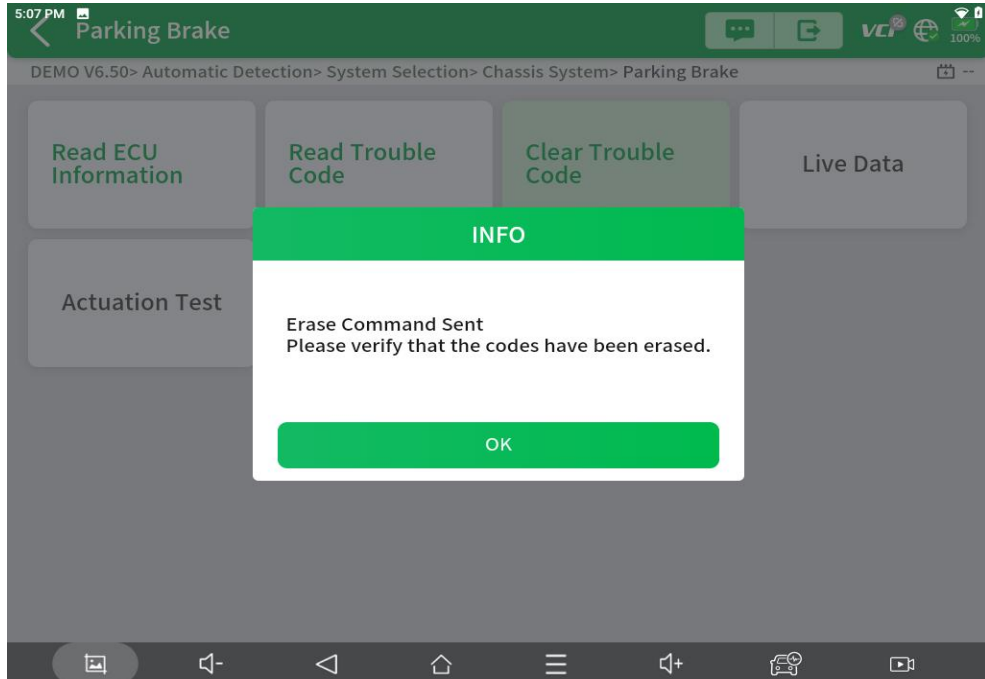

【Read Live Data】

Real-time information about various sensors is called “Live Data”. Live Data includes **parameter identifications (PIDs)** of the running engine such as oil pressure, temperature, engine speed, fuel oil temperature, coolant temperature, intake air temperature, etc. Based on these parameters, we can predict directly where the problem lies, which helps to narrow the scope of maintenance. For some vehicles, during their actual operation, the problems such as performance characteristics or sensitivity reduction, can be evaluated using live data.

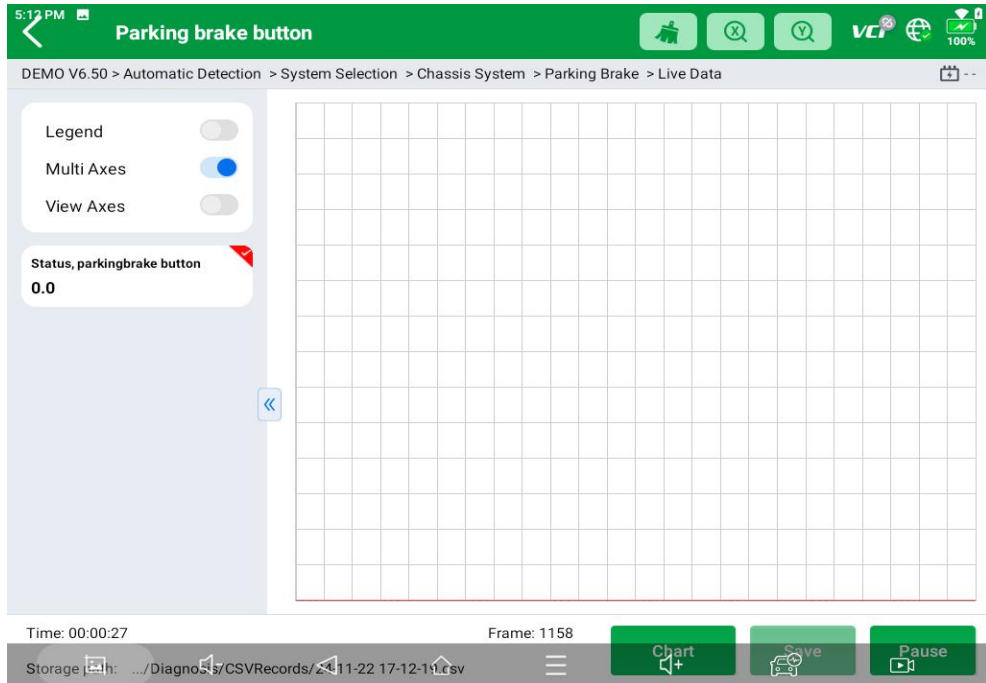

Click the magnifying glass on the top right, you can search for related PIDs based on keywords.

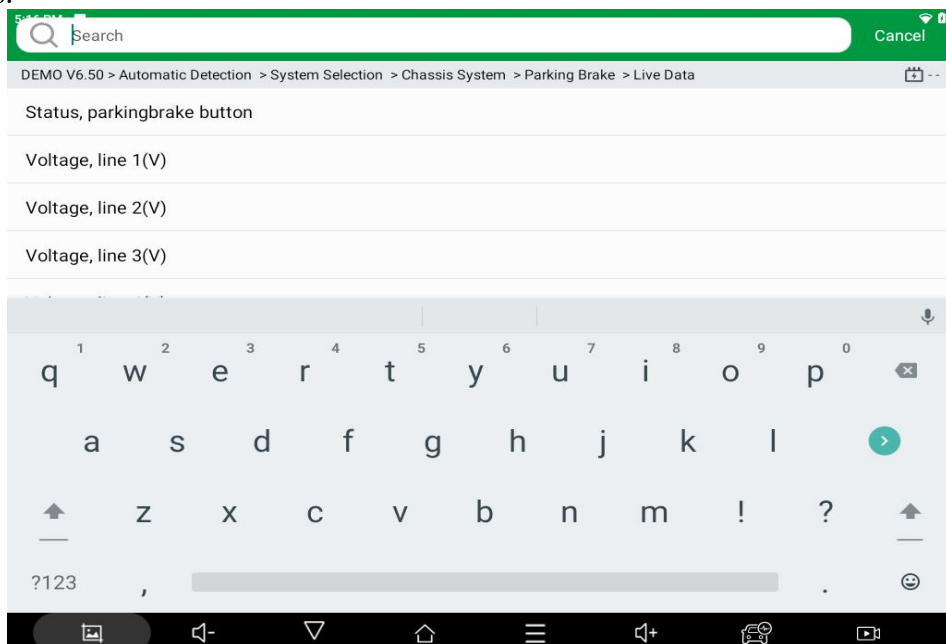

【Actuation test (Bi-directional control)】

Actuation test, also known as bidirectional control, is a generic term used to describe sending and receiving information between one device and another. This function is used mainly to judge whether these actuating components of the engine are working properly.

The vehicle engineers responsible for designing computer control systems programmed them so a scan tool could request information or command a module to perform specific tests and functions. Some manufacturers refer to bidirectional controls as functional tests, actuator tests, inspection tests, system tests or the like. Reinitialization and reprogramming also can be included in the list of bidirectional controls.

This function allows the device to send information to and receive information from, vehicle control modules. For example, in the case of OBD II generic information Mode 1 (which relates to data parameters), the scan tool user initiates a request for information from the powertrain control module (PCM), and the PCM responds by sending the information back to the scan tool for display. Most enhanced scan tools also can actuate relays, injectors and coils, perform system tests, etc. Users could check the individual part to see what is working properly by actuation test.



【Special functions】

Usually, special functions provide various reset or re-learning functions menus for most vehicle systems. You can easily and quickly solve some faults through special functions for your car. After some functions are successfully executed, fault codes will be generated, which need to be cleared manually after the car is running for a little while which could include a single start of the engine or multiple warm up cycles.

And under each system, you can view the special features supported by that system. Different models and systems often have different special functions. Even for the same system of the same model, the years and ECU type may lead to different special functions supported.

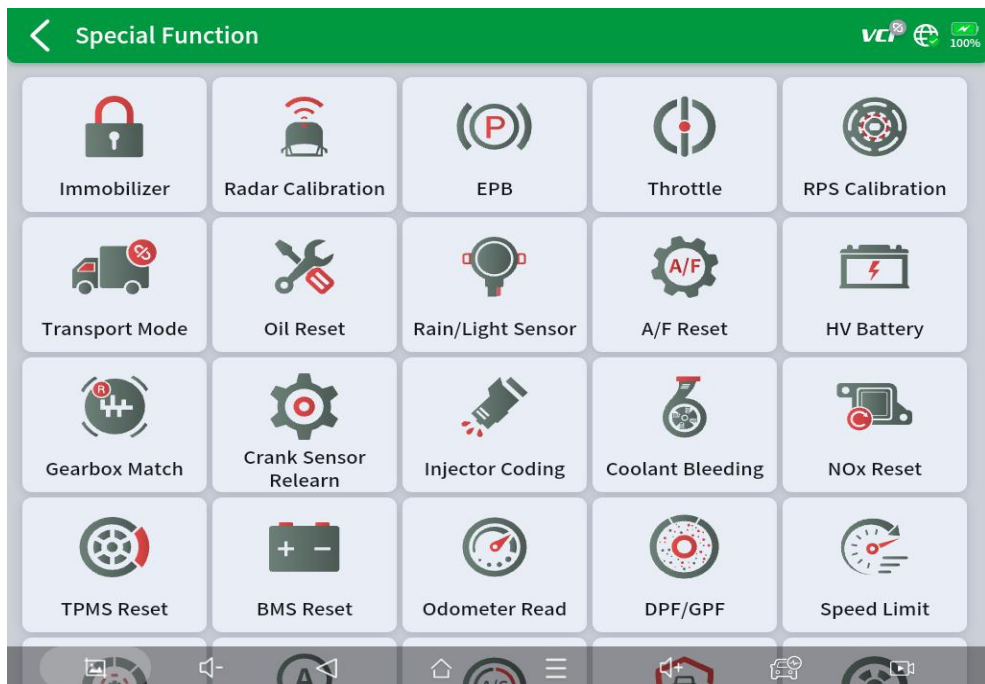

3.5.3 Component Test

Test vehicle units (Support disassembled units).

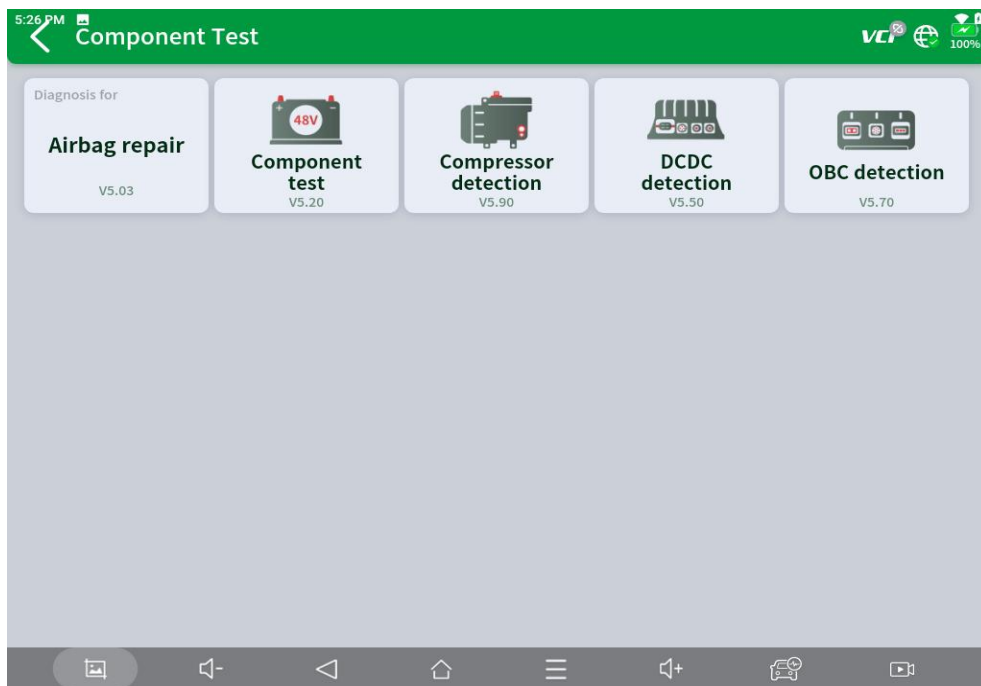

3.5.4 Updates

Click **【Update All】** to upgrade all supported diagnostic software.



3.5.5 Report

Here to check the saved files, including Diagnosis Report, CSV View.

【Diagnosis Report】 Diagnosis report generated during vehicle diagnosis

【CSV View】 Here to view the saved live data



4 Remote Control

Tap on "Remote" to start the TeamViewer quick support program, which is a simple, fast, and secure remote-control screen. You can use this application to enable someone else to use their computer running TeamViewer software to control your tablet over the Internet. This feature is frequently used by XTOOL's technical support centre when remotely helping customers with technical support.

Computers and mobile devices running TeamViewer are identified by a globally unique ID. When the remote application is started for the first time, the ID will be automatically generated according to the hardware characteristics and will not be changed in the future. This TeamViewer ID can individually access all TeamViewer clients.

Before launching the remote desktop application, make sure that the tablet is connected to the Internet so that you can access the tablet to receive remote support from a third party. If you encounter problems and are not able to solve them, you could open this application and ask for remote assistance.

To obtain remote support from your partners or XTOOL AfterSalesService Center:
support1@xtooltech.com | support2@xtooltech.com

1. Turn on the power of the tablet.
2. Click Remote in the Diagnostic application. The TeamViewer screen is displayed, and the device ID will be generated.
3. Your partner must install the remote-control software on their computer by downloading the full version of the TeamViewer program (<http://www.teamviewer.com>) online, and then start the software on their computer at the same time, to provide support and remote control of the tablet.
4. Provide your ID to the partner or XTOOL technician, and then wait for them to send you a remote-control request.
5. A pop-up window will be displayed, asking you to permit the remote-control program to control your device.
6. Click Allow to accept, or click Reject to reject.

How to connect to this device

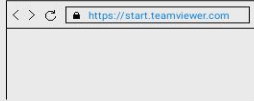

On any other device, go to
<https://start.teamviewer.com>

Your ID -

Activating TeamViewer...

